

Peelers Vegetable Peeler, 15 kg - Abrasive Plate

ITEM # _____

MODEL # _____

NAME # _____

SIS # _____

AIA # _____

601900 (T15E1)

 15 kg vegetable peeler.
Abrasive plate

601903 (T15E324)

 15 kg vegetable peeler.
Abrasive plate. Discharge
height 890mm

Main Features

- Transparent lid in damage-resistant plastic material allows visibility during peeling cycle.
- Supplied with:
-abrasive plate
- Removable rotating plate covered in very resistant abrasive material (silicon carbide).
- Peels are reduced to small pieces to facilitate drainage process.
- Pulse function to control the unloading operation.
- Removable water inlet, clipped to the cover, designed to serve as a spray to clean the machine.
- Timer with countdown display.
- Magnetic detectors will stop the machine from operating when the lid and/or door are opened.
- Suitable for 80-300 meals per service.

Construction

- Complete stainless steel construction.
- IP55 waterproof touch button control panel.
- Transparent BPA free cover incorporates a magnetic safety system which stops the machine if lid is not properly closed.

Included Accessories

- 1 of Abrasive plate for T10 or T15 PNC 653203

Optional Accessories

- Washing plate PNC 653058
- Abrasive plate for small onions, shallots and garlic T10 or T15, 388 mm dia. PNC 653184
- Abrasive plate for T10 or T15 PNC 653203
- Knife plate for 10 and 15 kg vegetable peelers PNC 653204
- Abrasive plate for large onions T10 and T15 PNC 653205
- Drying basket for T15 PNC 653209
- S/S SEASHELL PLATE - 10/15KG VEG.PEELERS PNC 653620
- - NOT TRANSLATED - PNC 653783
- - NOT TRANSLATED - PNC 653784

APPROVAL: _____

Front

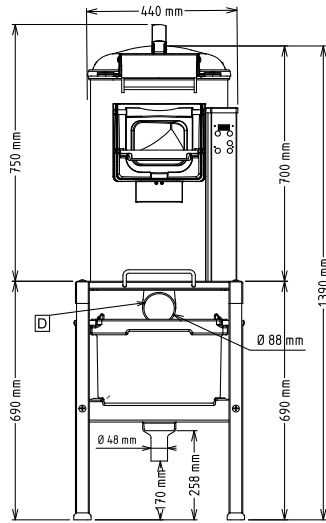

Side

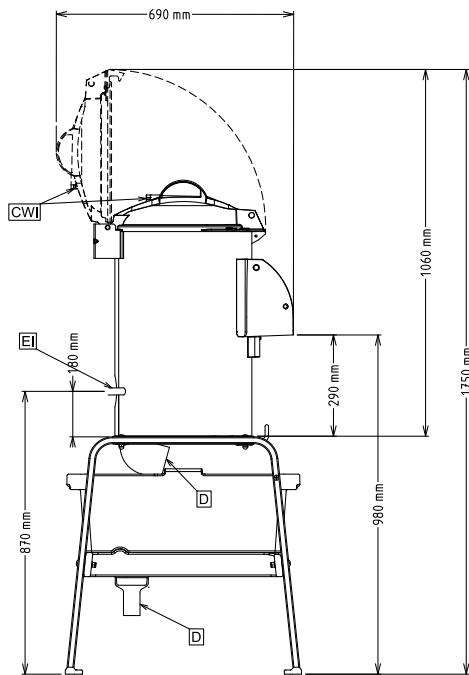

CWI = Cold Water inlet 1 (cleaning)
 D = Drain
 EI = Electrical inlet (power)

Top

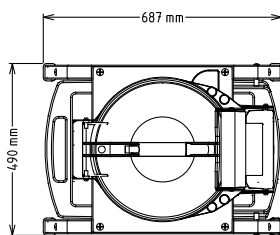

Electric

Supply voltage:

601900 (T15E1)

220-240 V/1N ph/50/60 Hz

200-240/380-440 V/3

601903 (T15E324)

ph/50/60 Hz

Electrical power max.:

0.37 kW

Total Watts:

0.37 kW

Capacity:

Performance (up to):

240 kg/hour

Capacity:

15 litres

Key Information:

External dimensions, Width: 440 mm

External dimensions, Depth: 690 mm

External dimensions, Height: 750 mm

Shipping weight:

601900 (T15E1)

50 kg

601903 (T15E324)

47 kg